

## VerseBay

Reliable, effective lighting in the industrial workplace is a crucial factor influencing productivity, safety and staff well-being. The VerseBay high-bay luminaire clearly embodies such lighting requirements. Its solid, quality construction and reliable performance excels even in the toughest working environments. Its specially designed beam regulator allows light distribution to be optimally set for a broad range of work areas using just a single reflector.

VerseBay also embodies extraordinary features that dramatically eases installation and maintenance. An external waterproof connector makes installation faster than ever while its tool-less lamp replacement is quick and hassle-free. So whatever your high-bay lighting requirements – industrial areas, logistics centers or public spaces – VerseBay offers a host of innovative features that can add new dimensions to versatility and ease of installation.



Type	HPK518
Features	<p>Ideal for industrial applications with extreme conditions such as high temperatures, dusty and even humid environments</p> <p>Owing to its high-quality materials, functional design and the modular construction, VerseBay is also particularly suitable for many large spaces with high ceilings</p> <p>An integrated beam regulator allows you to adjust beam spread to accommodate two different light beams with only one reflector</p> <p>Tool-less installation and wiring</p> <p>Easy to maintain</p> <p>Made of top quality materials</p>
Light source	<p>High-intensity discharge:</p> <ul style="list-style-type: none"> <li>1 x HPL-N / E40 / 250W, 400 W</li> <li>1 x HPI-Plus / E40 / 250 W</li> <li>1 x HPI-Plus / E40 / 400 BUS</li> <li>1 x SON / E40 / 150, 250, 400 W</li> </ul>
Gear	<p>Electro magnetic (low loss), 220V/50Hz, 230-240V/50Hz; 220V/60Hz:</p> <p>Parallel compensated (IC)</p>

Optics	<p>Light output ratio of 70% with glass cover</p> <p>Wide-beam; narrow beam with aluminum reflector</p> <p>Prismatic reflector for 150W &amp; 250W lamp options</p> <p>Thermoplastic cover</p>
Materials and finish	<p>Sandblasted aluminium die-cast housing plate</p> <p>Black-painted aluminium die-cast housing</p> <p>Anodized aluminum reflector</p> <p>Tempered glass and silicon gasket</p> <p>PA66 + 30% glass fibre lamp holder adapter</p> <p>Zinc-coated mounting bracket</p>
Installation	Suspension, surface or pipe-mounted
Classifications	<p>Class I</p> <p>IP65 with aluminium reflector</p> <p>IP20 with prismatic reflector</p>
Ambient temperature	-20°C - 35°C (aluminum reflector with or without glass cover)
Norms compliance	<p>Electrical: IEC60598/GB7000</p> <p>Vibration: GB/T 4857.18</p> <p>(for aluminium reflector version)</p>
Main applications	General industries, heavy industries, logistic centers, power plants, steel plants, public spaces, food processing industries



IP65 Aluminium reflectors

IP20 Prismatic reflectors





Aluminium reflector with protection glass cover

Prismatic reflector with cover lens

Aluminium reflector with thermoplastic cover



Aluminium Reflector + Glass Cover

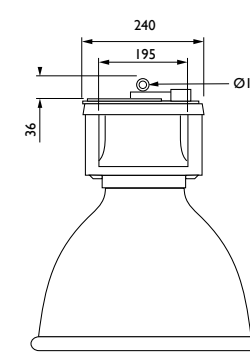
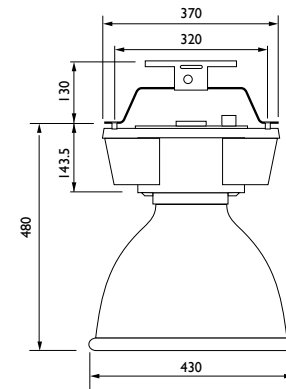

Prismatic Reflector + Cover Lens

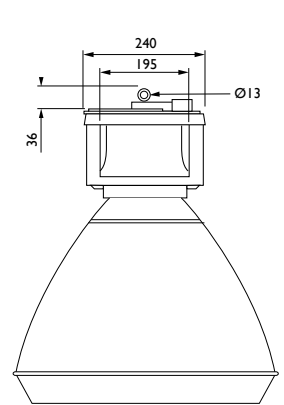
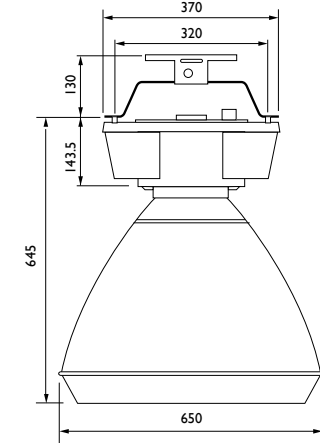

Aluminium Reflector + Thermoplastic Cover

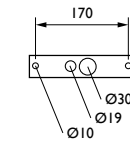
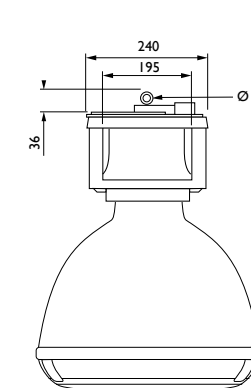
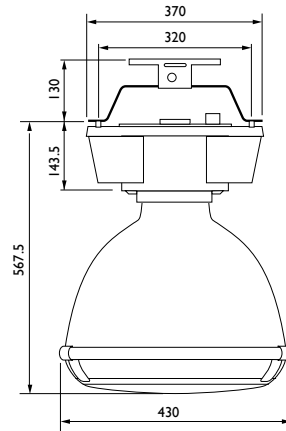

# VerseBay HPK518

## Preferred selection

Product ID	Type	Weight (kg)	Order Code
HPK518 1xHPI-P250W-BU IC 220 50	Gear Unit	12.00	911401089280
HPK518 1xHPI-P250W-BU IC 220 60	Gear Unit	12.00	911401096180
HPK518 1xHPI-P250W-BU IC 230-240	Gear Unit	12.00	911401089980
HPK518 1xHPI-P250W-BU IC PR 220 50	Gear Unit	12.00	911401091380
HPK518 1xHPI-P250W-BU IC PR 220 60	Gear Unit	12.00	911401096180
HPK518 1xHPI-P250W-BU IC PR 230-240	Gear Unit	12.00	911401090680
HPK518 1xHPI-P400W-BUS IC 220 50	Gear Unit	12.00	911401089380
HPK518 1xHPI-P400W-BUS IC 220 60	Gear Unit	12.00	911401096180
HPK518 1xHPI-P400W-BUS IC 230-240	Gear Unit	12.00	911401090080
HPK518 1xHPL-N250W IC 220 50	Gear Unit	12.00	911401089080
HPK518 1xHPL-N250W IC 220 60	Gear Unit	12.00	911401096180
HPK518 1xHPL-N250W IC 230-240	Gear Unit	12.00	911401089780
HPK518 1xHPL-N250W IC PR 220 50	Gear Unit	12.00	911401091180
HPK518 1xHPL-N250W IC PR 220 60	Gear Unit	12.00	911401096180
HPK518 1xHPL-N250W IC PR 230-240	Gear Unit	12.00	911401090480
HPK518 1xHPL-N400W IC 220 50	Gear Unit	12.00	911401089180
HPK518 1xHPL-N400W IC 220 60	Gear Unit	12.00	911401096180
HPK518 1xHPL-N400W IC 230-240	Gear Unit	12.00	911401089880
HPK518 1xSON150W IC 220 50	Gear Unit	12.00	911401089480
HPK518 1xSON150W IC 220 60	Gear Unit	12.00	911401096180
HPK518 1xSON150W IC 230-240	Gear Unit	12.00	911401090180

Product ID	Type	Weight (kg)	Order Code
HPK518 1xSON150W IC PR 220 50	Gear Unit	12.00	911401091580
HPK518 1xSON150W IC PR 220 60	Gear Unit	12.00	911401096180
HPK518 1xSON150W IC PR 230-240	Gear Unit	12.00	911401090880
HPK518 1xSON250W IC 220 50	Gear Unit	12.00	911401089580
HPK518 1xSON250W IC 220 60	Gear Unit	12.00	911401096180
HPK518 1xSON250W IC 230-240	Gear Unit	12.00	911401090280
HPK518 1xSON250W IC PR 220 50	Gear Unit	12.00	911401091680
HPK518 1xSON250W IC PR 220 60	Gear Unit	12.00	911401096180
HPK518 1xSON250W IC PR 230-240	Gear Unit	12.00	911401090980
HPK518 1xSON400W IC 220 50	Gear Unit	12.00	911401089680
HPK518 1xSON400W IC 220 60	Gear Unit	12.00	911401096180
HPK518 1xSON400W IC 230-240	Gear Unit	12.00	911401090380
GPK518 C-WB/NB Alu $\Phi$ 425mm	Aluminium reflector	4.50	911401095980
ZDK518 PG IP65 $\Phi$ 425mm	Glass cover	5.00	911401085480
GPK518 PC-L IP20 $\Phi$ 645mm	Prismatic reflector	22.00	911401096080
GPK518 PC-C IP20 $\Phi$ 645mm	Prismatic cover	9.50	910401995180
ZPK518 Mounting Bracket	Mounting bracket	3.00	911401085580

Please contact your local Philips representative for additional configurations

HPK518 1xHPI-P400W BUS WB Alu Reflector with PG-IP65

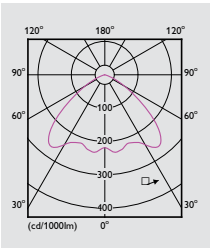

HPK518 1xHPI-P400W BUS NB Alu Reflector with PG-IP65

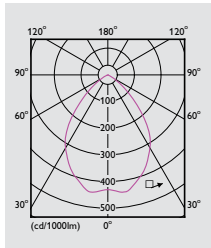

HPK518 1xSON400W WB Alu Reflector with PG-IP65

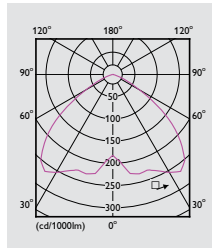

HPK518 1xSON400W NB Alu Reflector with PG-IP65

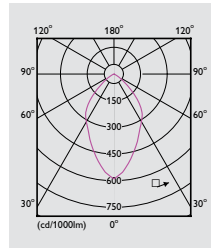

HPK518 1xHPL-N400W WB Alu Reflector with PG-IP65

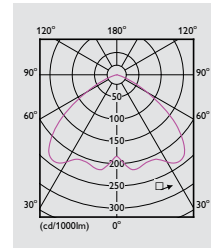

HPK518 1xHPL-N400W NB Alu Reflector with PG-IP65

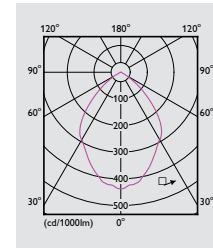

HPK518 1xHPI-P250W BU WB Alu Reflector with PG-IP65

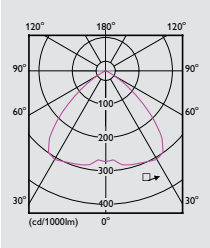

HPK518 1xHPI-P250W BU NB Alu Reflector with PG-IP65

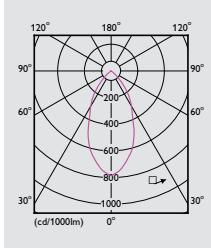

HPK518 1xSON250W WB Alu Reflector with PG-IP65

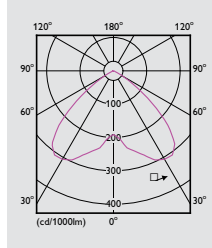

HPK518 1xSON250W NB Alu Reflector with PG-IP65

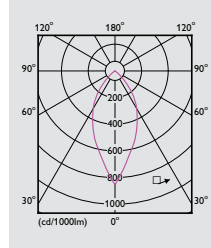

HPK518 1xHPL-N250W WB Alu Reflector with PG-IP65

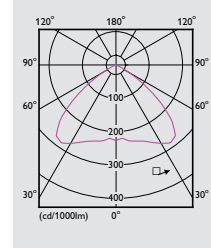

HPK518 1xHPL-N250W NB Alu Reflector with PG-IP65

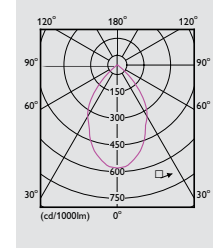

HPK518 1xSON150W WB Alu Reflector with PG-IP65

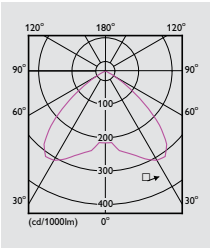

HPK518 1xSON150W NB Alu Reflector with PG-IP65

